



Rocky Mountain Rafts

Raft Measurements

(Measurements may vary slightly. Measure YOUR raft before building your frame.)

	Length	Width	Rise	Tube Diam.	D-Rings/ Handles	Inside L/W	Flat Area Length	Width c/c	Length c/c	Weight	Inside Depth Top of Tube to top of floor.
SB-90	9' 2"	60"	27"	18" > 14"	8/2	79"/24"	40"	42"	79"	67 lbs	10"

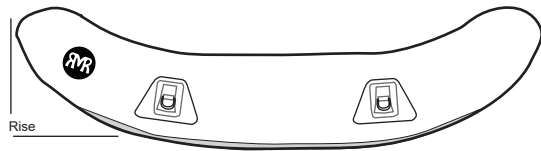
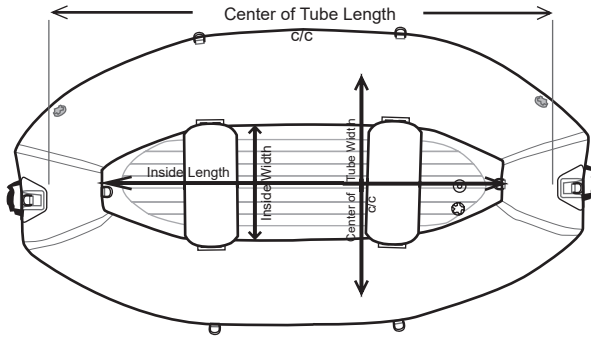

	Length	Width	Rise	Tube Diam.	D-Rings/ Handles	Inside L/W	Flat Area Length	Width c/c	Length c/c	Weight	Inside Depth Top of Tube to top of floor.
SB-105	10' 6"	62"	27"	18"	8/2	91"/26"	56"	45"	110"	79 lbs	10"

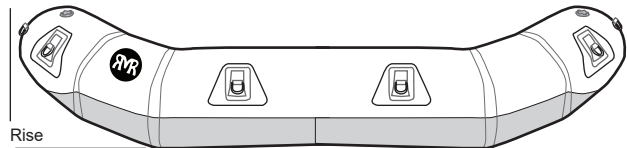
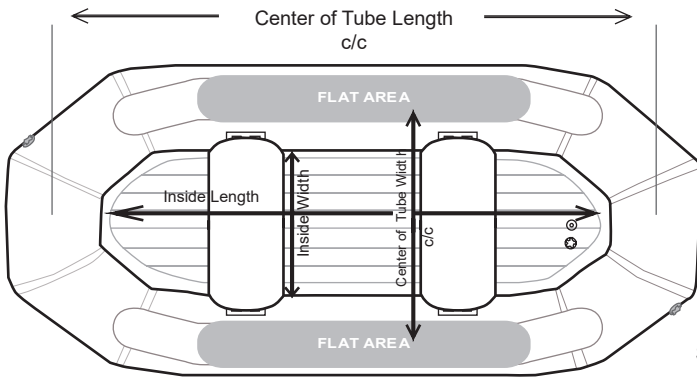

SB-105

	Length	Width	Rise	Tube Diam.	D-Rings/ Handles	Inside L/W	Flat Area Length	Width c/c	Length c/c	Weight	Inside Depth Top of Tube to top of floor.
SB-120	12'	74"	27"	18"	12/6	109"/36"	64"	53"	126"	120 lbs	10" SB
SBDS-120											12" SBDS

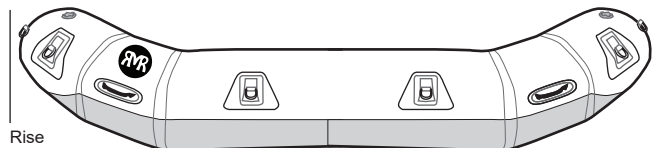
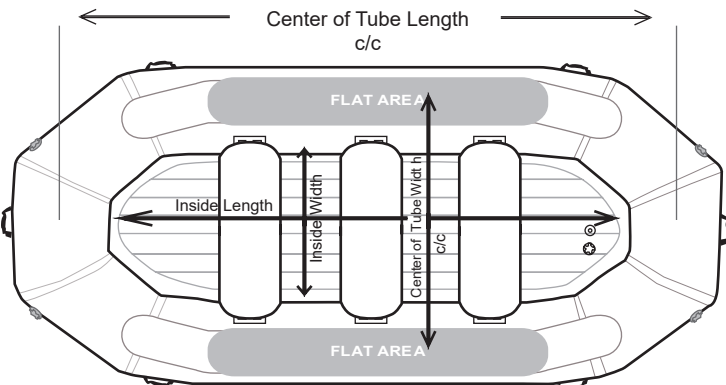

Rise

	Length	Width	Rise	Tube Diam.	D-Rings/ Handles	Inside L/W	Flat Area Length	Width c/c	Length c/c	Weight	Inside Depth Top of Tube to top of floor.
SB-130	12' 10"	75"	28"	19"	12/6	117"/ 35"	71"	56"	135"	136 lbs	11" SB
SBDS-130											13" SBDS

	Length	Width	Rise	Tube Diam.	D-Rings/ Handles	Inside L/W	Flat Area Length	Width c/c	Length c/c	Weight	Inside Depth Top of Tube to top of floor.
SB-140	14'	85"	29"	20"	12/6	128"/ 45"	81"	62"	148"	158 lbs	12" SB
SBDS-140											14" SBDS

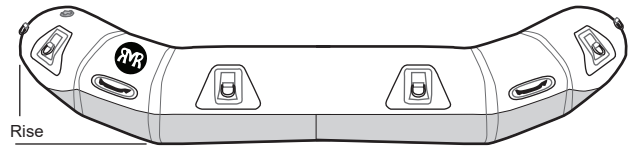
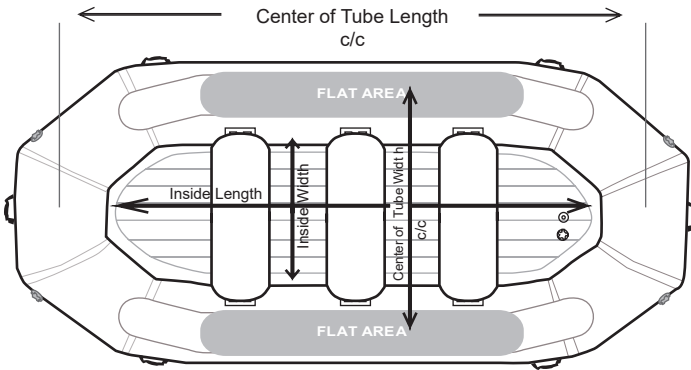

	Length	Width	Rise	Tube Diam.	D-Rings/ Handles	Inside L/W	Flat Area Length	Width c/c	Length c/c	Weight	Inside Depth Top of Tube to top of floor.
SB-160	16'	92"	31"	22"	12/8	148"/ 47"	87"	69"	170"	195 lbs	14" SB
SBDS-160											16" SBDS

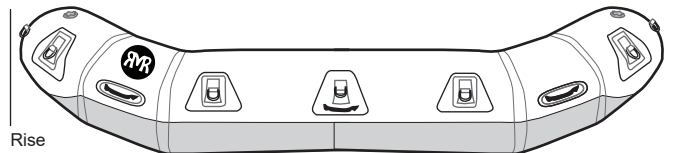
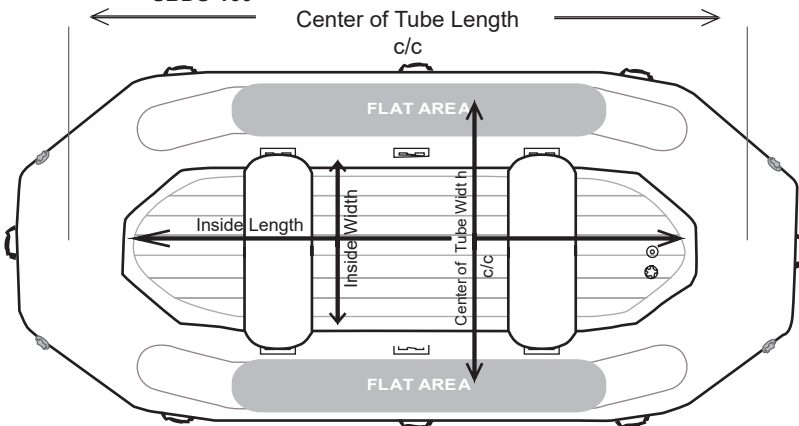

Raft Measurements for Peak series (PK-135, PK-160) PhatCat (PC-120)

	Length	Width	Rise	Tube Diam.	D-Rings/ Handles/ Footcups	Inside L/W	Flat Area Length	Width c/c	Length c/c	Weight	Inside Depth Top of Tube to top of floor.
PK-135	13' 7"	79"	29"	20">17"	12/2/2	129"/ 39"	62"	59"	148"	140lbs	10"

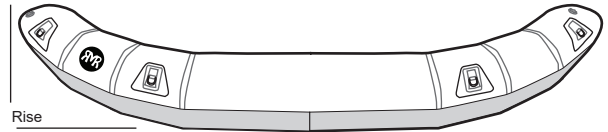
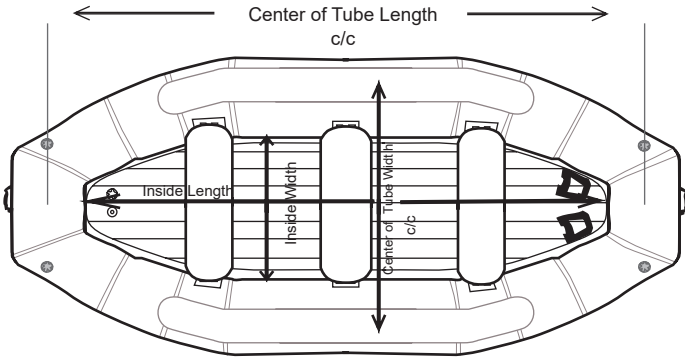

	Length	Width	Rise	Tube Diam.	D-Rings/ Handles/ Footcups	Inside L/W	Flat Area Length	Width c/c	Length c/c	Weight	Inside Depth Top of Tube to top of floor.
PK-160	15' 10"	90"	29"	23">20"	16/2/2	150"/ 44"	68"	67"	171"	199lbs	15"

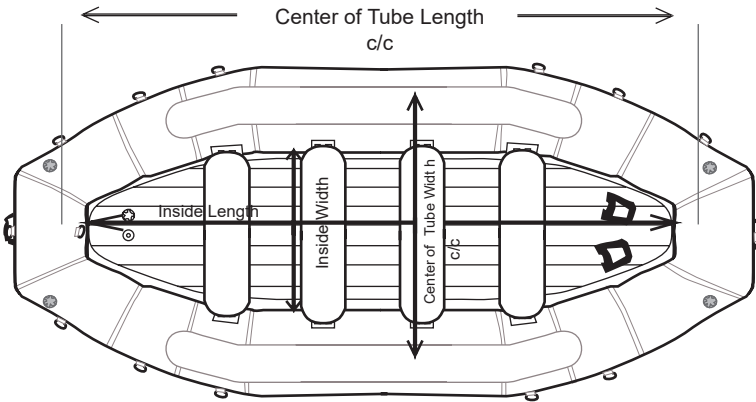

	Length	Width	Rise	Tube Diam.	D-Rings/ Footcups	Flat Area Length	Cockpit Width c/c	Cockpit Length c/c	Weight	Inside Depth Top of Tube to top of floor.
PC-120	11' 10"	66"	25"	23"	12/2	47"	20"	35"	59lbs	13"

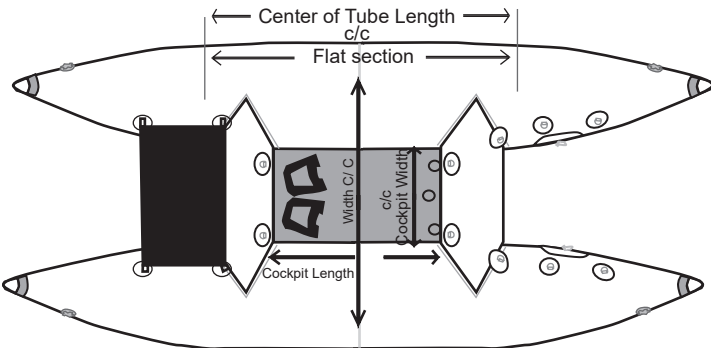

Just add water